

Load direction/加载方向

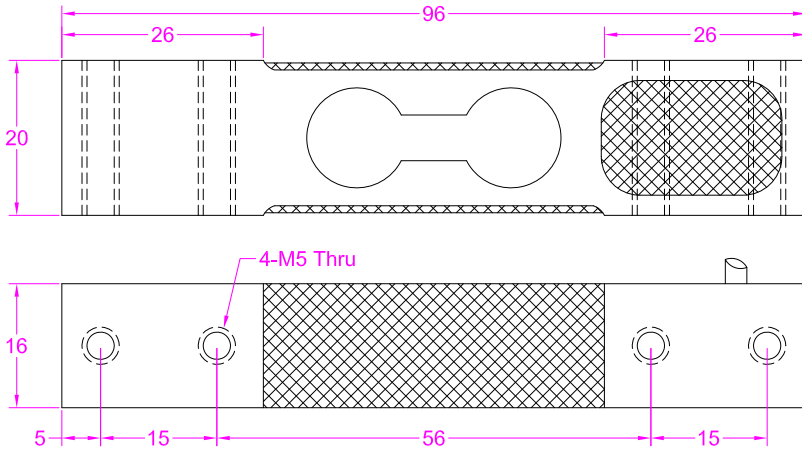

Wiring Diagram/接线图

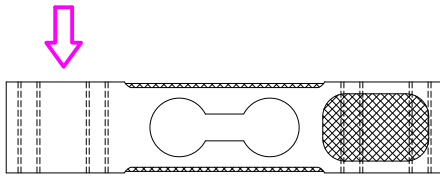
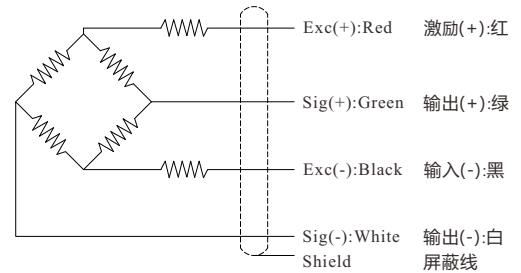

--- Specifications / 规格参数 ---

Capacity/量程	3/5/10/15/20kg		
Rated Output 额定输出	2.0±10% mV/V	Compensated Temp. 温度补偿范围	-10...+40°C
Excitation 激励电压	3~15V	Operating Temp. 工作温度范围	-20...+60°C
Zero Balance 零点输出	±5% of R.O.	Temp. Shift Zero 零点温度漂移	±0.05% of R.O./10°C
Nonlinearity 非线性	±0.02% of R.O.	Temp. Shift Span 灵敏度温度漂移	±0.03% of R.O./10°C
Hysteresis 滞后	±0.015% of R.O.	Input Resistance 输入阻抗	1130±20 Ω
Nonrepeatability 非重复性	±0.015% of R.O.	Output Resistance 输出阻抗	1000±10 Ω
Creep(30min) 蠕变(30min)	±0.03% of R.O.	Insulation Resistance 绝缘阻抗	>2000M Ω (50V)
Safe Overload 安全过载	150% of F.S.	Ingress Protection 防护等级	IP65
Ultimate Overload 极限过载	200% of F.S.	Material of Element 弹性体材料	Aluminum alloy 铝合金
Cable 导线	Ø4*400mm 4-core shielded cable(Longer cable available) Ø4*400mm 4芯屏蔽线		
R.O.=Rated Output/额定输出 F.S.=Full Scale/满量程			

• Subject to change without notice / 如有更改,不另行通知